



48500 Kato Road  
Fremont, CA 94538 USA

## Product Specification

### High-Speed, High Power Photodetector

Part No.:

**PD-200**

Revision: **2.5**

Page 1 of 12

## PRODUCT SPECIFICATIONS

Product:	<b>High-Speed, High Power Photodetector</b>
Description:	<b>20GHz BW, 13dBm Input Max, 1550nm</b>
Optoplex P/N:	<b>PD-200</b>
Spec Revision:	<b>2.5</b>
Date of Update:	<b>6/6/2016</b>

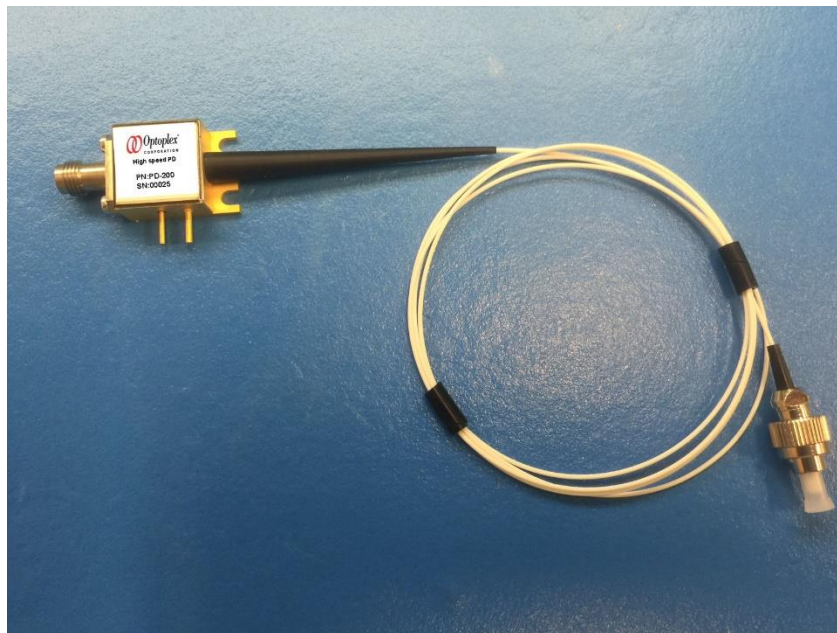



48500 Kato Road  
Fremont, CA 94538 USA

## Product Specification

### High-Speed, High Power Photodetector

Part No.:

**PD-200**

Revision: **2.5**

Page 2 of 12

## Revision History

Rev.	Date	Revision History	Originated	Signed by
1.0	11/19/2015	Initial Release	Jindong Li	James Pang
2.0	1/25/2016	Updated the mechanical design (dimensions and Pin-out) per customer's request	Jindong Li	James Pang
2.1	2/23/2016	Updated the mechanical design per customer's request	Jindong Li	James Pang
2.2	4/4/2016	Change the connector for K to V	Jindong Li	James Pang
2.3	4/27/2016	Change the connector from FC/APC to FC/UPC	Jindong Li	James Pang
2.4	6/4/2016	Added Figure 2.2, equivalent circuit diagram Min BW changed from 18 to 20 GHz. S22 divided into three levels, 0 ~ 10GHz < -10dB; 10 ~ 15GHz < -6dB; 15 ~ 20GHz < -4dB Updated Figures 9.2, 9.4, 9.5, & 9.6	Songtao Du	James Pang
2.5	6/6/2016	Added a product photo on the front page	Xinghui Cai	James Pang



48500 Kato Road  
Fremont, CA 94538 USA

## Product Specification

### High-Speed, High Power Photodetector

Part No.:

**PD-200**

Revision: **2.5**

Page 3 of 12

## Table of Contents

1. Introduction .....	4
2. Block Diagram.....	5
2.1 Pin-Out Arrangement.....	5
2.2 Equivalent Circuit Diagram .....	5
3. Absolute Maximum Rating.....	6
4. Optical and Electrical Performance .....	6
5. Mechanical Outline Drawing.....	7
6. Optical Input.....	8
7. Measured Performance (as Reference only) .....	8
7.1. Relative DC Responsivity.....	8
7.2 Typical Frequency Response Curves.....	9
7.3 10Gbps Eye Diagram.....	9
7.4 Electrical Return Loss.....	10
7.5 Linearity vs Optical Input Power .....	10
7.6 Group Delay .....	11
8. Ordering Information.....	12
9. Contact Information.....	12

## Product Specification

### 1. Introduction

These high speed photodiode, PD-200, is hermetically sealed, high reliability, low harmonic distortion photodiode modules designed for high optical power applications with minimum bandwidths of 20 GHz. The device is well suited for receiver applications with optical pre-amplification, and is available either with or without an internal 50Ω termination. The photodiode module is available in either a V-connector package or a miniature surface mount package with CPW (coplanar waveguide) RF output.

#### Features:

- High Current Handling (up to 20 mA)
- Lowest PDL (typical 0.05 dB)
- Useable spectral wavelength range of 800-1650 nm
- Low Group Delay
- Low Harmonic Distortion
- V-connector (SMA) or surface mount package options
- Bellcore GR-468 Qualified
- One device for multiple wavelengths reduces operational & inventory costs

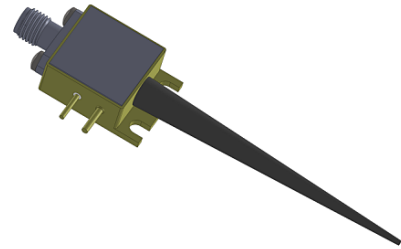

#### Applications:

- Optically Amplified Systems
- RZ, NRZ, Super FEC Formats to 20 Gb/s
- High Dynamic Range, Analog RF Links over Fiber
- Rapid Doppler-Shift LIDAR Measurements
- Coherent Lightwave Systems
- Ideal Front-End O/E Converter for Test Instruments

## 2. Block Diagram

### 2.1 Pin-Out Arrangement

Pin#	Description
1	Reverse Bias Voltage to PD
2	Ground of the PD (and the case)
3	RF output, V-Connector, Female

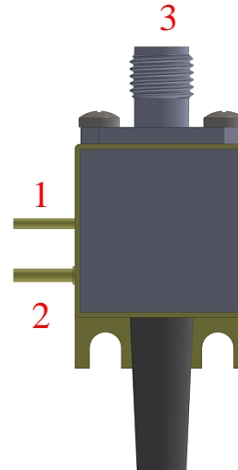

Figure 2.1, Functional block diagram of the linear high power photodetector

### 2.2 Equivalent Circuit Diagram

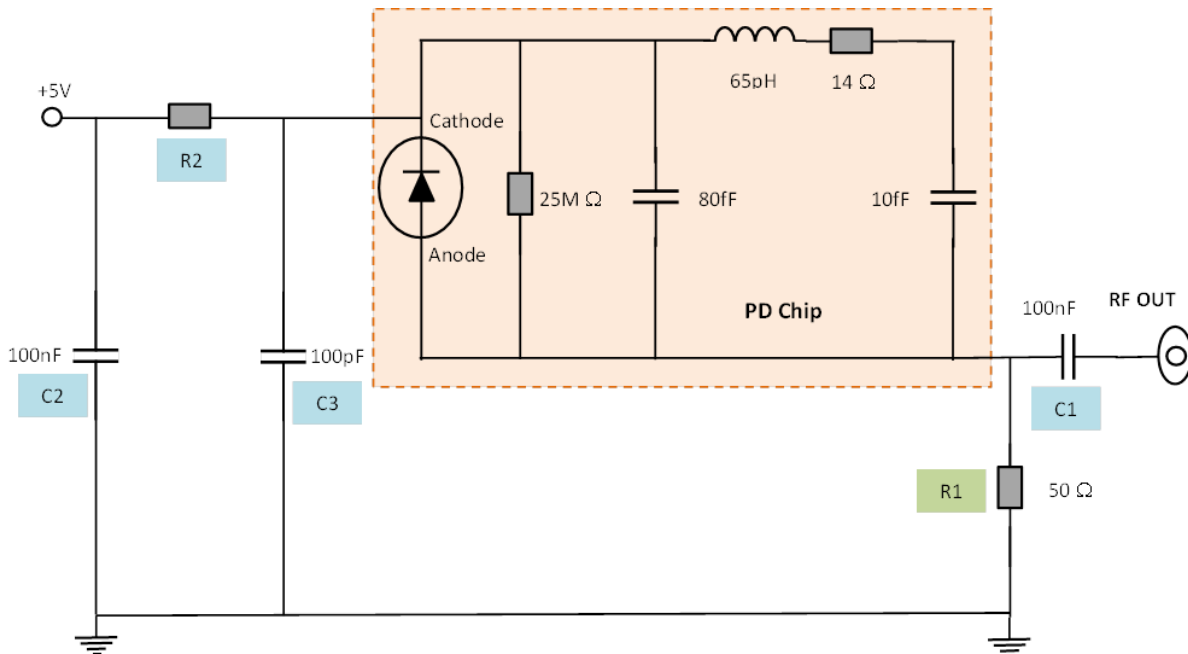

Figure 2.2, Equivalent Circuit Diagram



48500 Kato Road  
Fremont, CA 94538 USA

## Product Specification

### High-Speed, High Power Photodetector

Part No.:

**PD-200**

Revision: **2.5**

Page 6 of 12

## 3. Absolute Maximum Rating

Table 3.1, Absolute Maximum Rating

Parameter	Specification	Unit
Operating Temperature Range	0 to + 70	°C
Storage Temperature Range	- 40 to + 85	°C
Photodiode Bias $V_{bd}$	+ 4	V
Optical Input Power Damage Threshold <sup>(1)</sup>	+ 16	dBm peak
Lead Soldering Temperature (10 s)	250	°C

### Note:

- 1) Assumes NRZ with 50% duty cycle. Note that peak RZ or narrow pulse width will hit peak limit at lower average optical input powers than observed with 50% duty cycle data.

## 4. Optical and Electrical Performance

Table 4.1, Electrical Optical Properties of the High-Speed Photodiode

Parameter	Min	Typical	Max	Units
Responsivity (1480 nm~1620nm)	0.5	0.65	-	A / W
Logic Sense / Coupling	Positive Non-Inverting / AC 50 Ω			
3 dB Bandwidth <sup>(1)</sup>	20	22	-	GHz
Rise Time/ Fall Time/ FWHM <sup>(1)</sup>	-	14, 16, 22	-	ps
Dark Current @ 25C, 5V	-	5	10	nA
Electrical Return Loss, $S_{22}$	0 ~ 10 GHz	-	-10	dB
	10 ~ 15 GHz	-	-6	dB
	15 ~ 20 GHz	-	-4	dB
Optical Return Loss	27	30	-	dB
Bias Voltage	2.8	3.3	3.8	V
PDL @ 1550 nm	-	0.3	0.5	dB

### Notes

- 1) Power Bandwidth of unterminated PD-100, PD-150, or PD-200 is unspecified: Typically, it measures 50% of terminated version.

## 5. Mechanical Outline Drawing

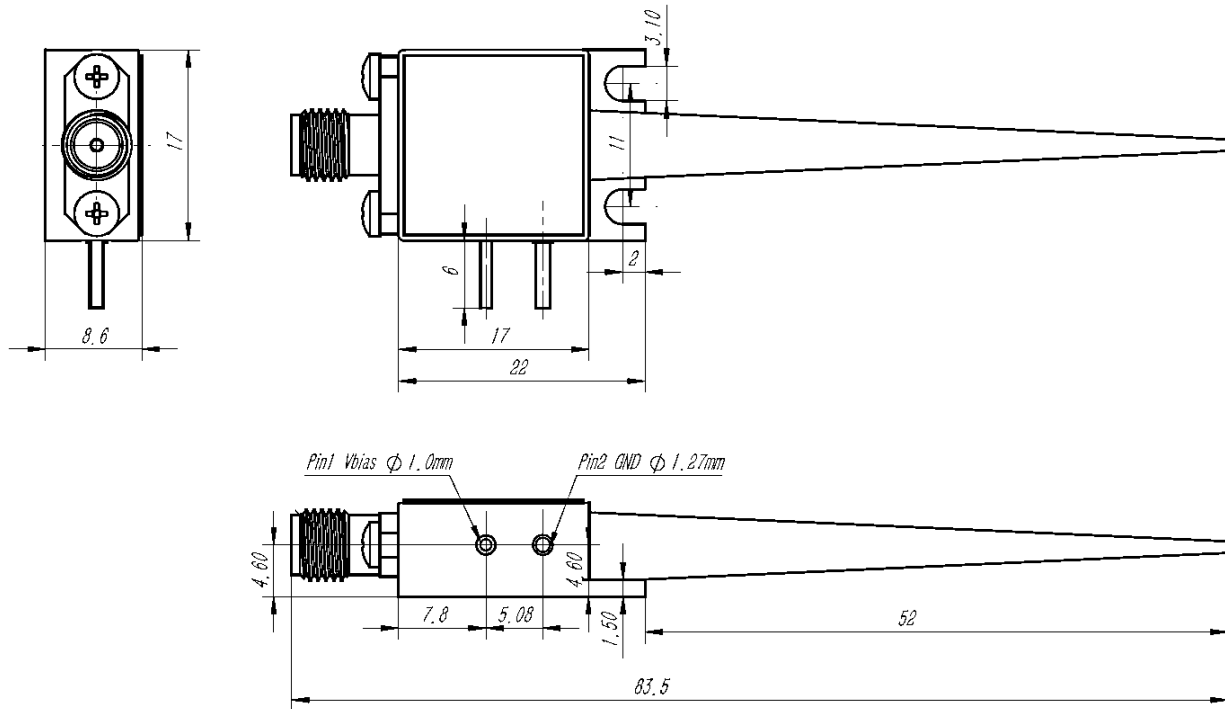

Figure 5.1, Mechanical drawing

## Operating Procedure:

### Always follow these steps:

1. Connect ground first
2. Use current-limited power supply
3. Apply stabilized bias of correct polarity
4. Apply optical power.

### Always shutdown with these steps:

1. Remove optical power before removing bias
2. Power down  $V_{bd}$
3. Disconnect device.



## 6. Optical Input

Table 7.1, Optical Input

Connector	Polish	Fiber	Buffer	Typical Length
<b>FC</b>	<b>UPC</b>	SMF28 or equivalent	900 um	1m

## 7 Measured Performance (as Reference only)

### 7.1. Relative DC Responsivity

### Relative DC Responsivity

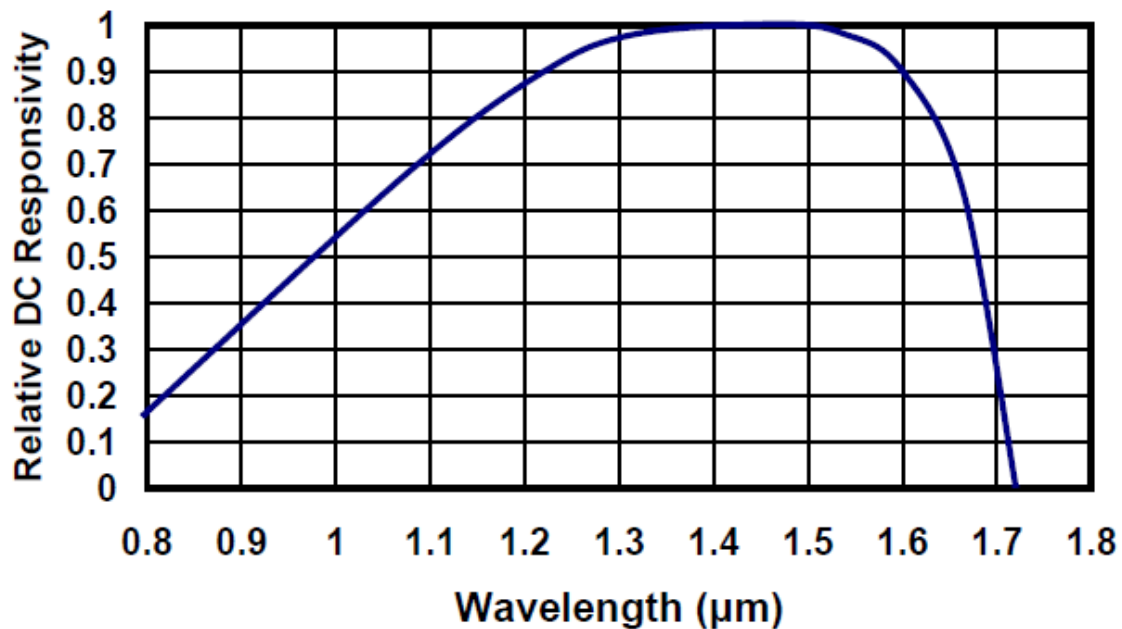

Figure 9.1, DC Responsivity



### 7.2 Typical Frequency Response Curves

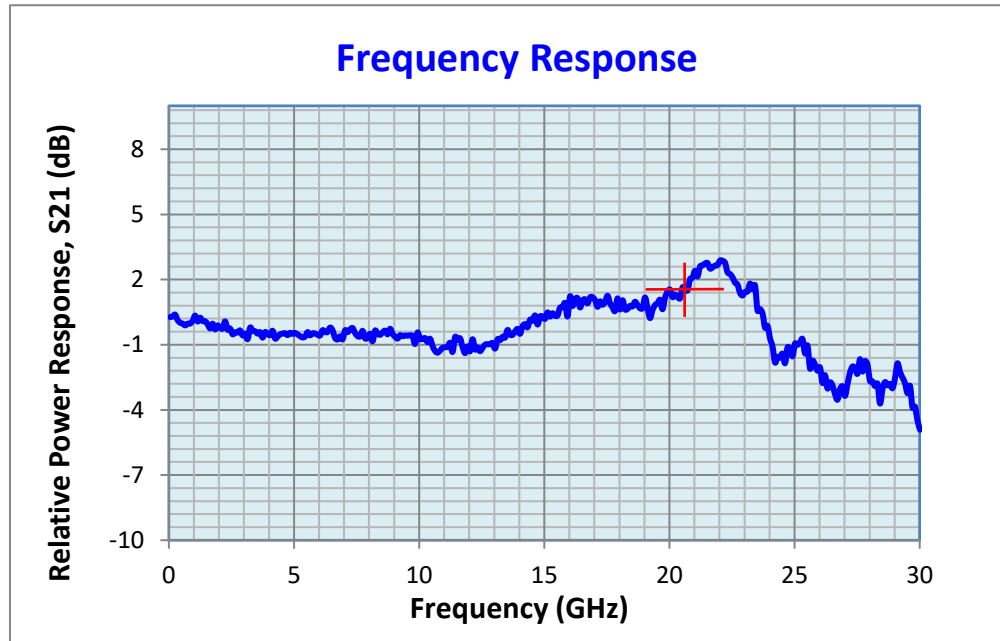

Figure 9.2, Frequency Response

### 7.3 10Gbps Eye Diagram

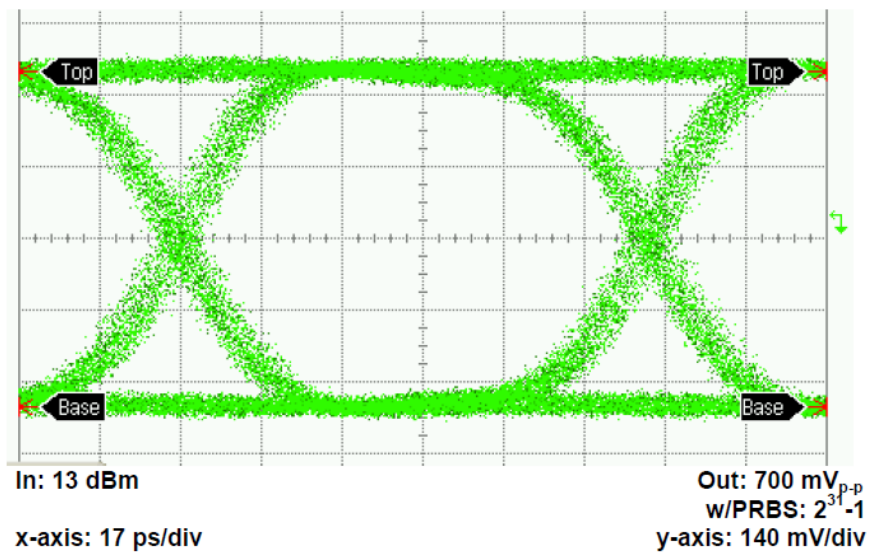

Figure 9.3, 10.7 Gb/s Eye Diagram (PD-150)

(Input: -3 dBm average optical power per photodiode, Output: 400 mV<sub>p-p</sub>)

### 7.4 Electrical Return Loss

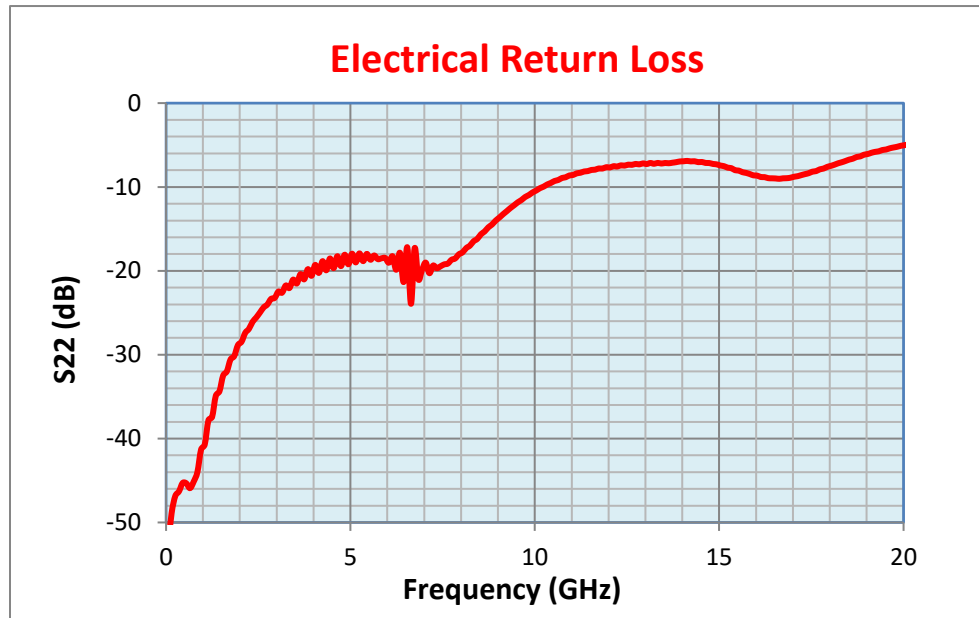

Figure 9.4, Electrical Return Loss(PD-200)

### 7.5 Linearity vs Optical Input Power

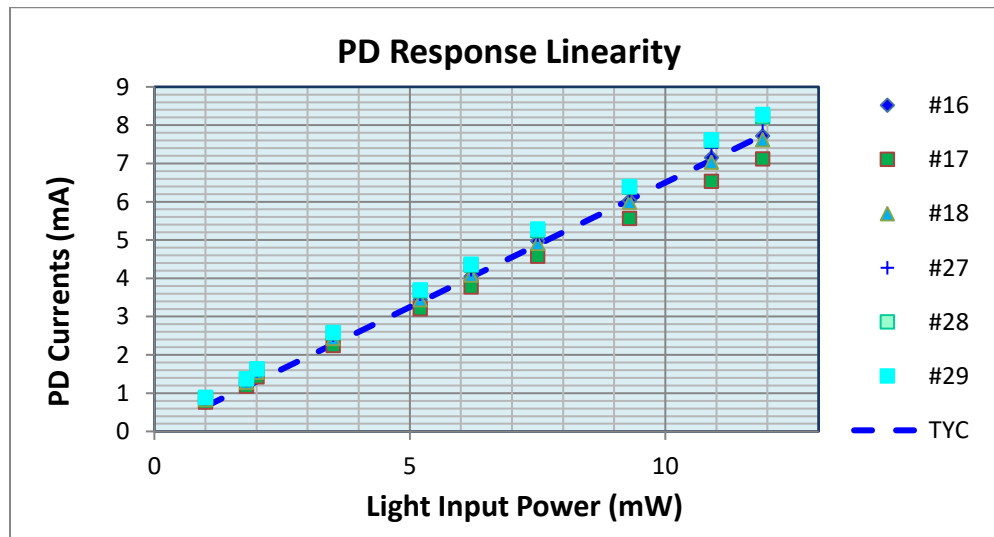

Figure 9.5, Linearity vs Optical Input Power

(Measured with 5V Reverse Bias, DC-coupled CW output. (The PD current, the current flowing through from the power supply to the cathode under bias of 5V. The current was measured with a multimeter in series between the power supply and Resistor R2)

### 7.6 Group Delay

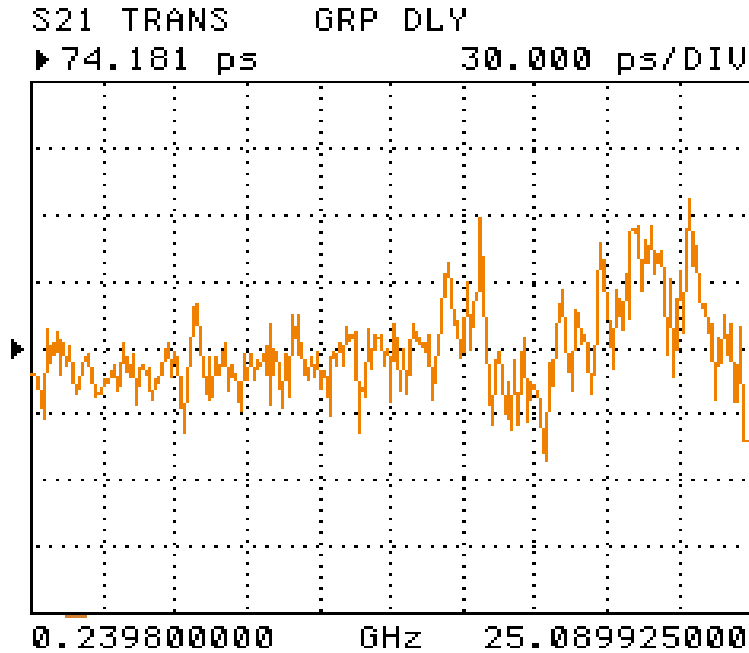

Figure 9.6, Group Delay



48500 Kato Road  
Fremont, CA 94538 USA

## Product Specification

### High-Speed, High Power Photodetector

Part No.:

**PD-200**

Revision: **2.5**

Page 12 of 12

## 8. Ordering Information

Product: **High-Speed, High Power Photodetector, C-Band, 20GHz BW, SMF Input Fiber, SMA Output**

Model Number: **PD-200**

## 9. Contact Information

### Optoplex Corporation

48500 Kato Road  
Fremont, CA 94538  
USA

Tel: (510) 490-9930

Fax: (510) 490-9330

[info@optoplex.com](mailto:info@optoplex.com)

[www.optoplex.com](http://www.optoplex.com)